

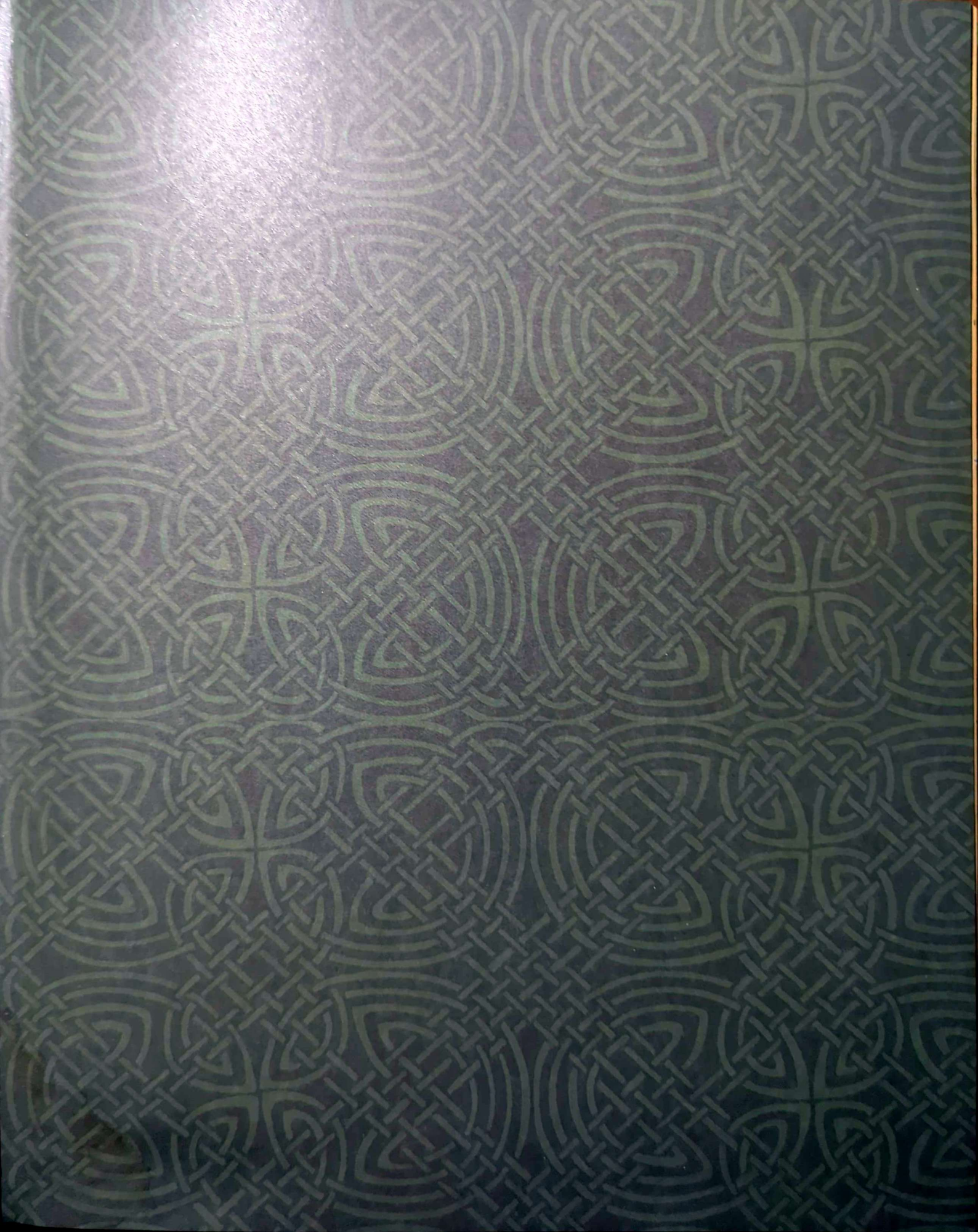

# LANTERN X-MANUAL

by Fuentun







Theory or Myth

Moon is new  
Earth was once like man  
Sun was once like Earth  
Some day Earth will be like a sun  
Moon will become like Earth  
and new moon will appear.

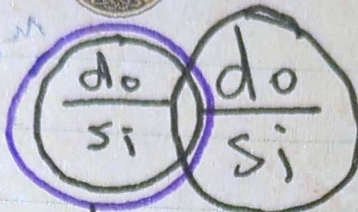

Positive  
Absolute 2,000

All Worlds

"Abstract"

la  
sol  
fa  
mi

All Stars

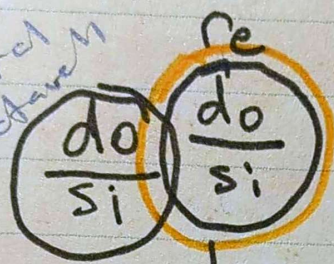

Material  
before M

Sol Sun 1,500

la  
sol  
fa  
fa  
mi

All Planets

organic life  
on earth

"sensitive  
film"

"transmitting  
& receiving  
planetary  
influences  
to/from  
Earth"

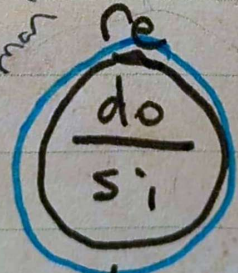

mi Earth 1,250

la  
sol  
fa  
mi  
re

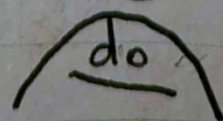
re  ~~re~~ Moon "growing  
shoot"  
1,125  
do Obsolete 1,000

Positive





123

6

6



246

12

3

4812

24

6



81624

48

3

163248

96

6



326448

192

3

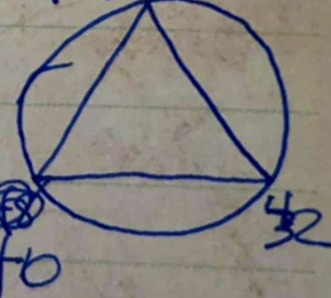
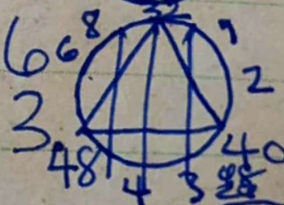
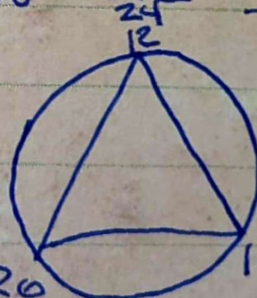
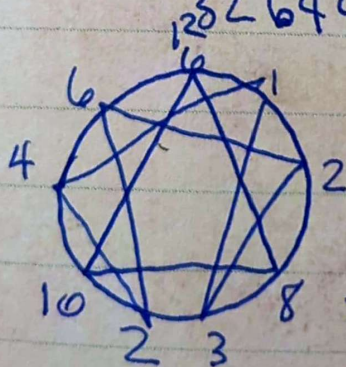

1326241



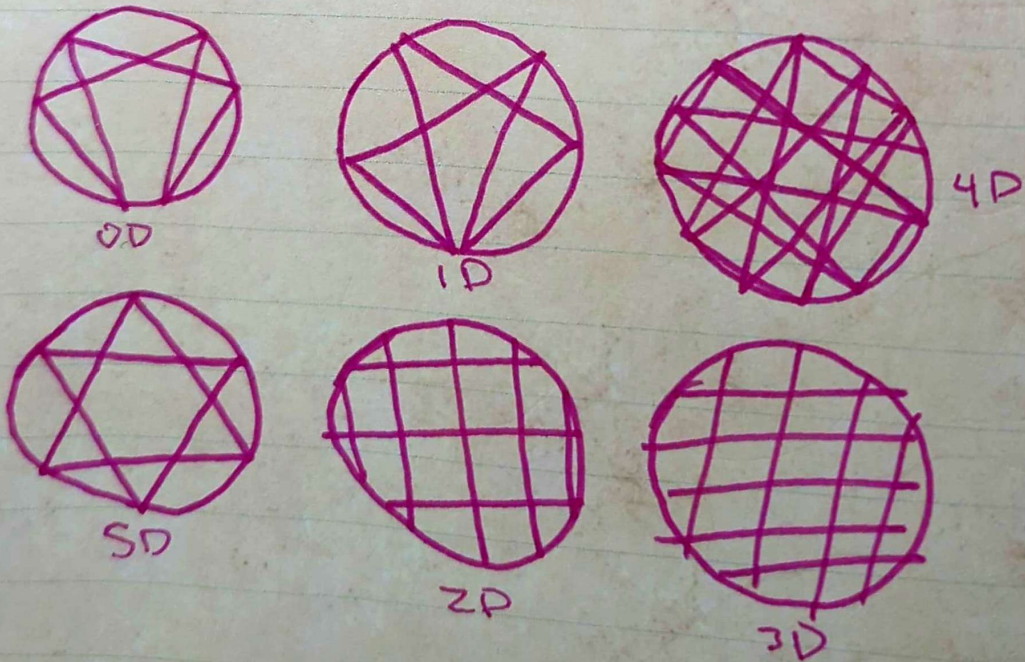
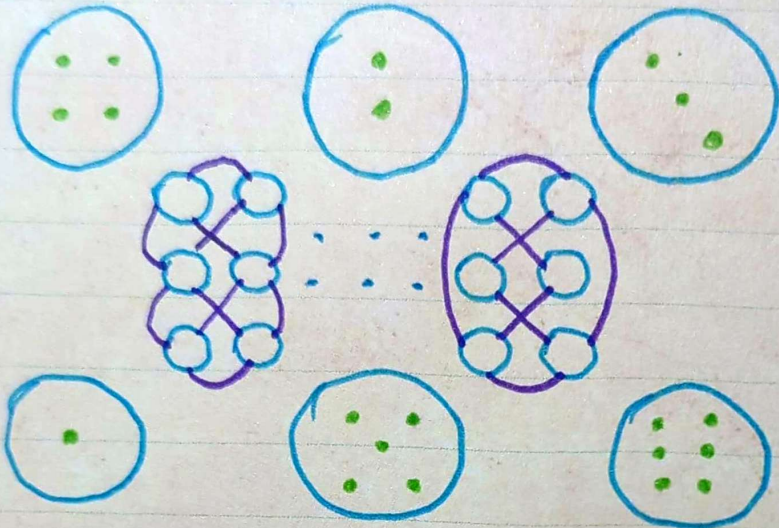



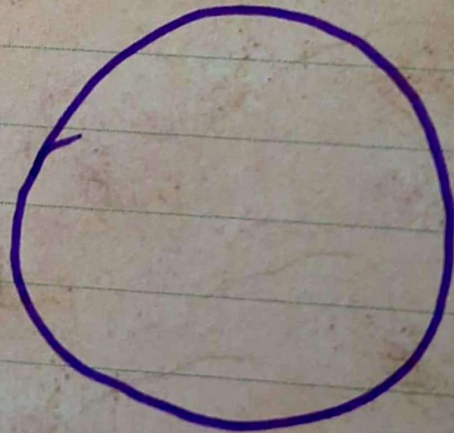
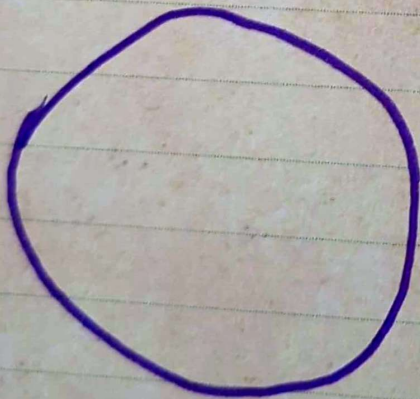
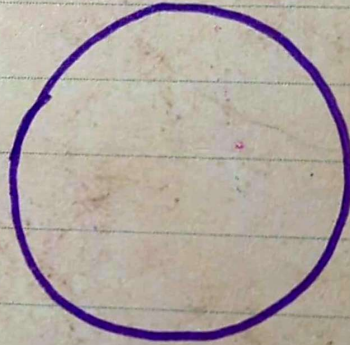
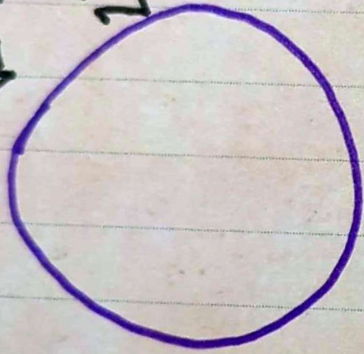
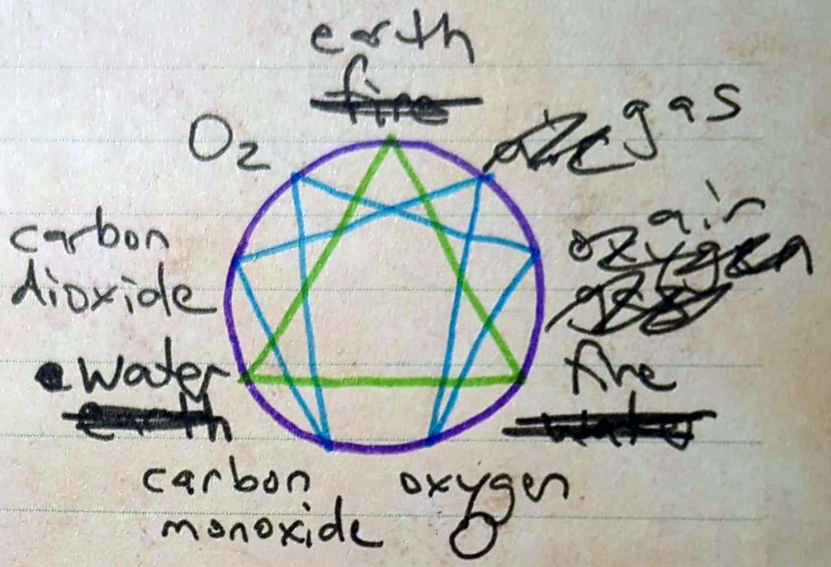
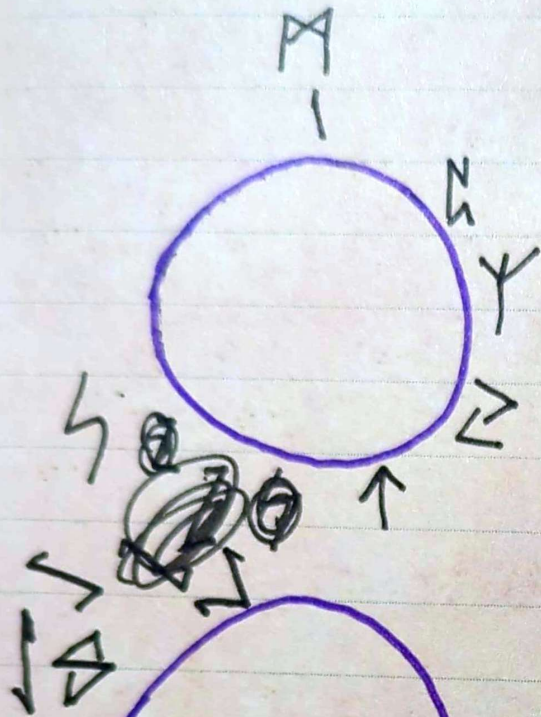



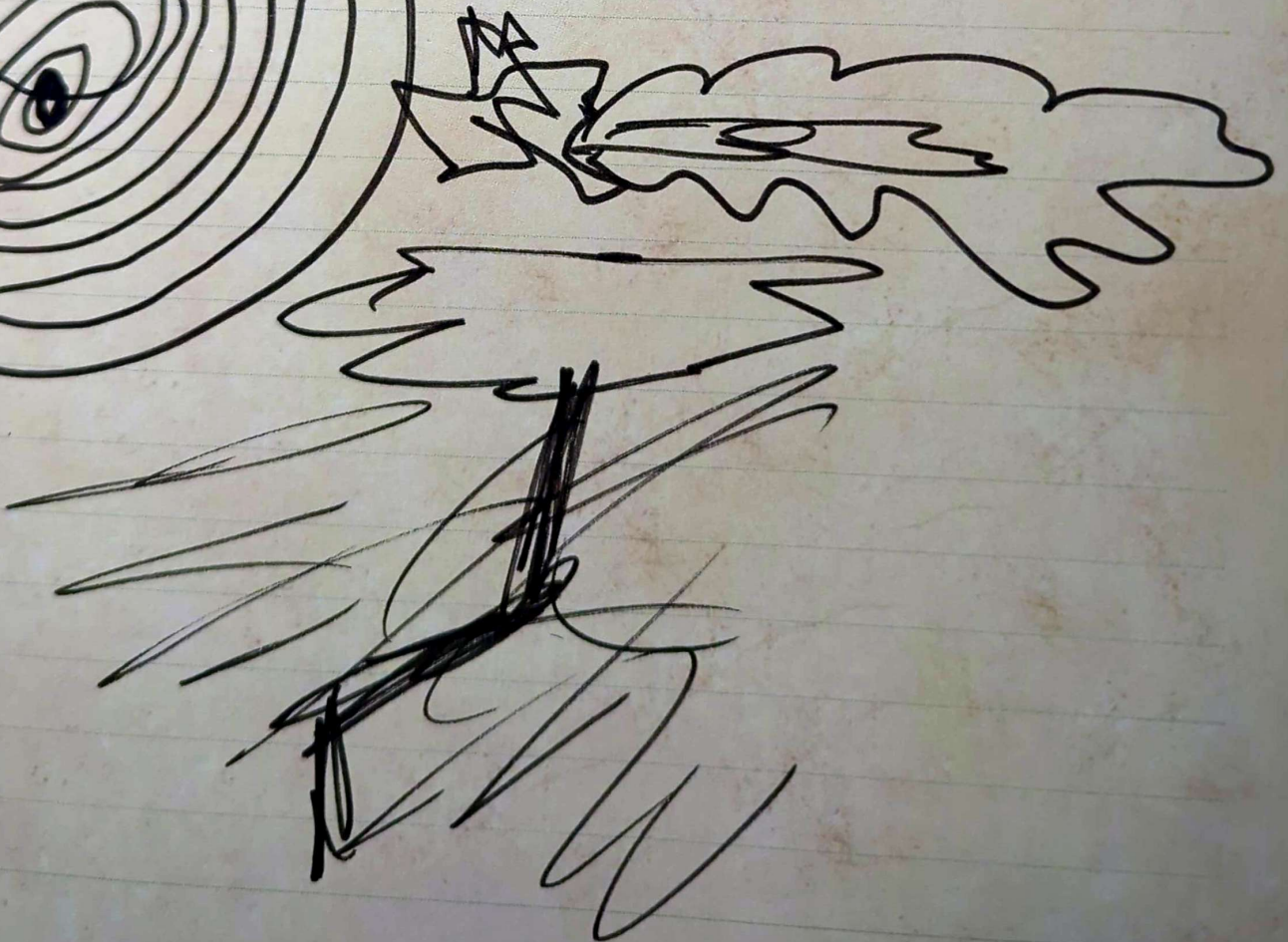
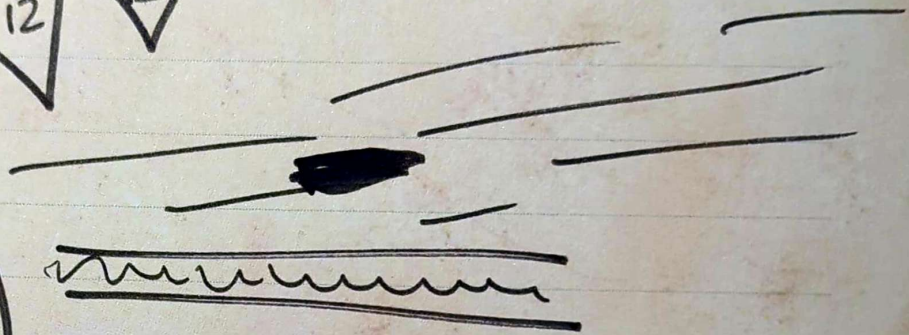
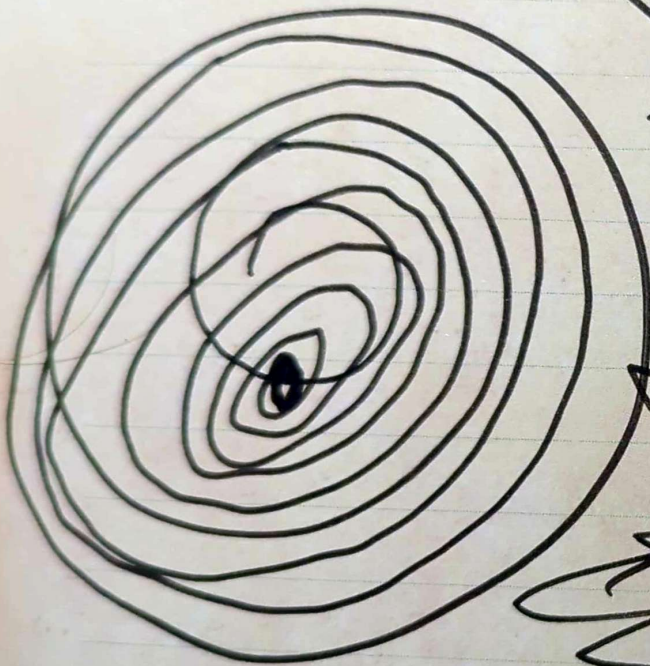
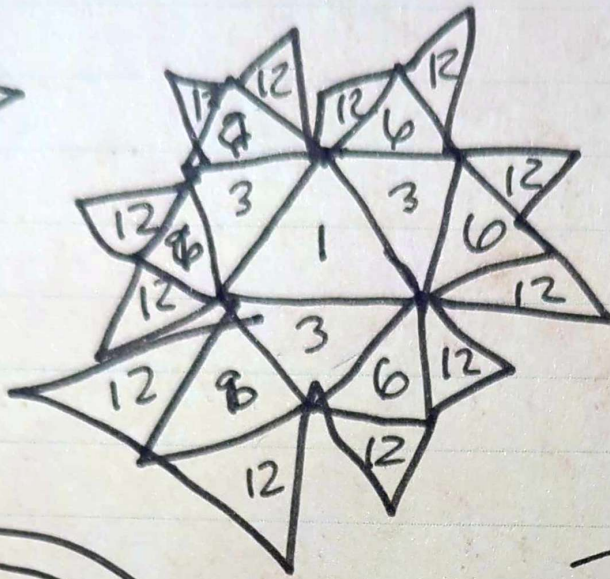
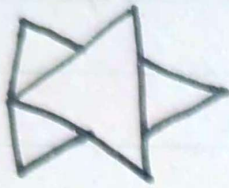





• —  
0D  
(nat)

1D(x)

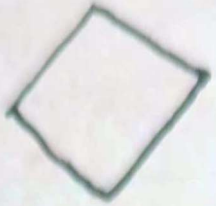

2D(xy)

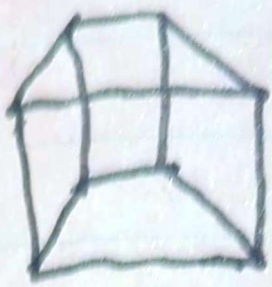

3D(xyz)



tesseract  
hypercube  
+ 4D (+)

• ||  
1  
2

parallel  
lines  
"duality"



3



4



5

pentagram  
pentacle



6

star  
of  
David



7

3D + origin  
or center



8

Seal  
of  
Solomon

Λ 3 C ) [ Γ G || I J K





1 2 3  
2 4 6  
4 8 12

8 16 32  
16 32 48  
32 64 96

64 128 192  
128 256 384  
256 512 768

512 1024 1536  
1024 2048 3072  
2048 4096 6144

1 1 1  
2 3 2

3 2 3 2 2 2

4 6 4

4 4 4 6 4 6

8 12 8

12 8 12





Λ 3 C > L Γ G H I J < L



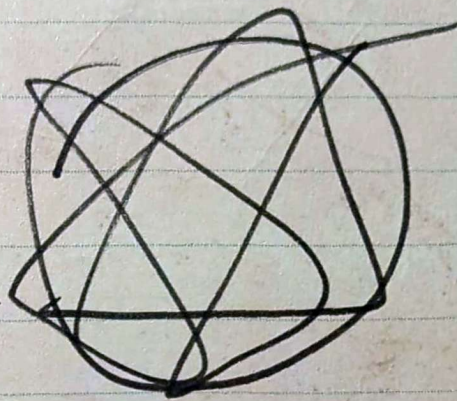
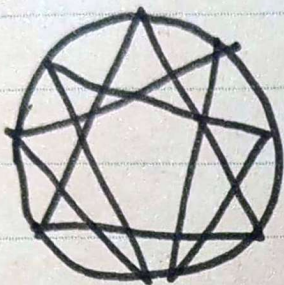
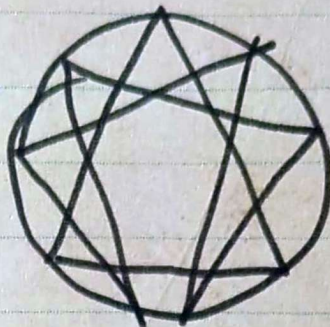
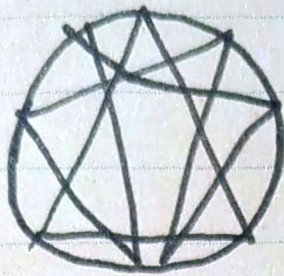

AS





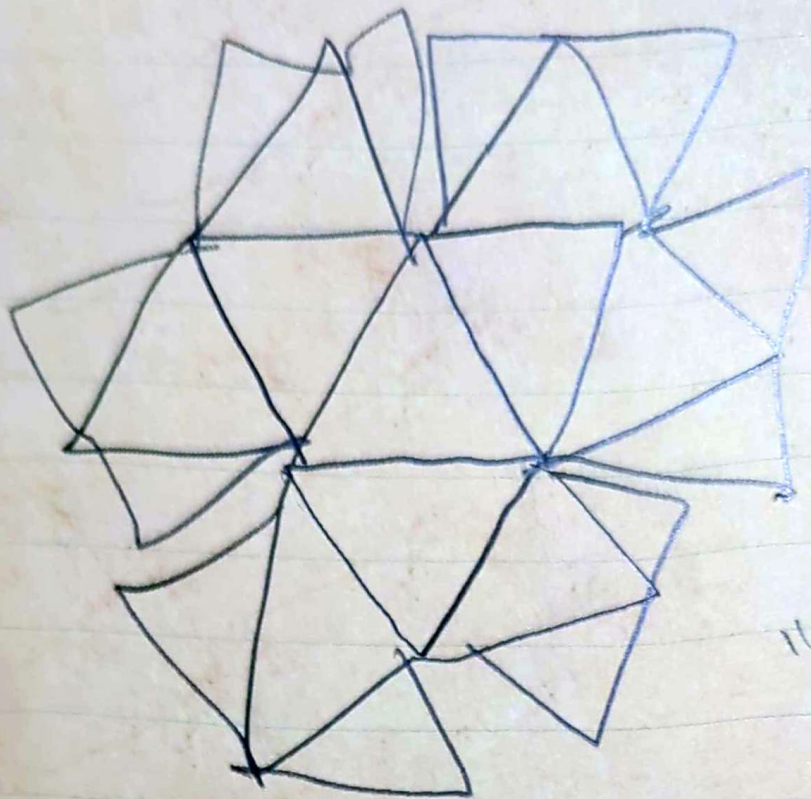

"unfolding  
blossom"

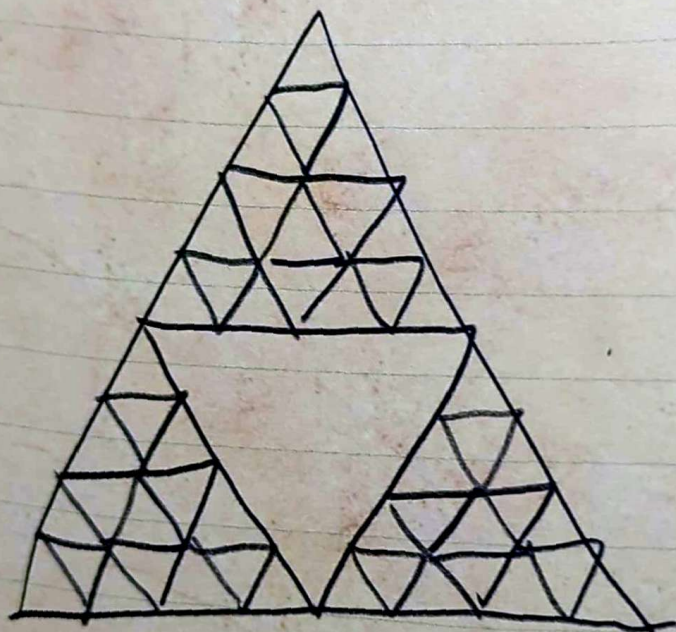



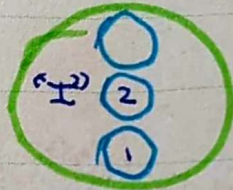
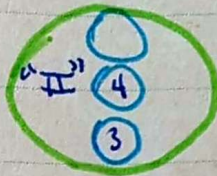
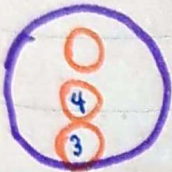
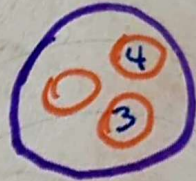
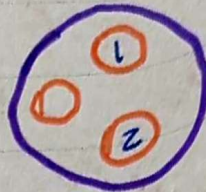
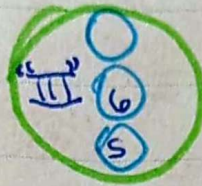
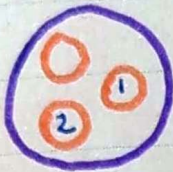
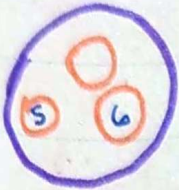
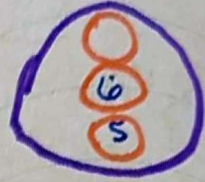
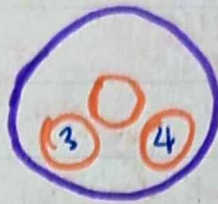
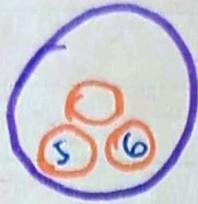

1

2

3

4

5

6

A

B

C

D

E

F

I

II

III

IIII

IIII

IIII I

one

two

three

four

five

six



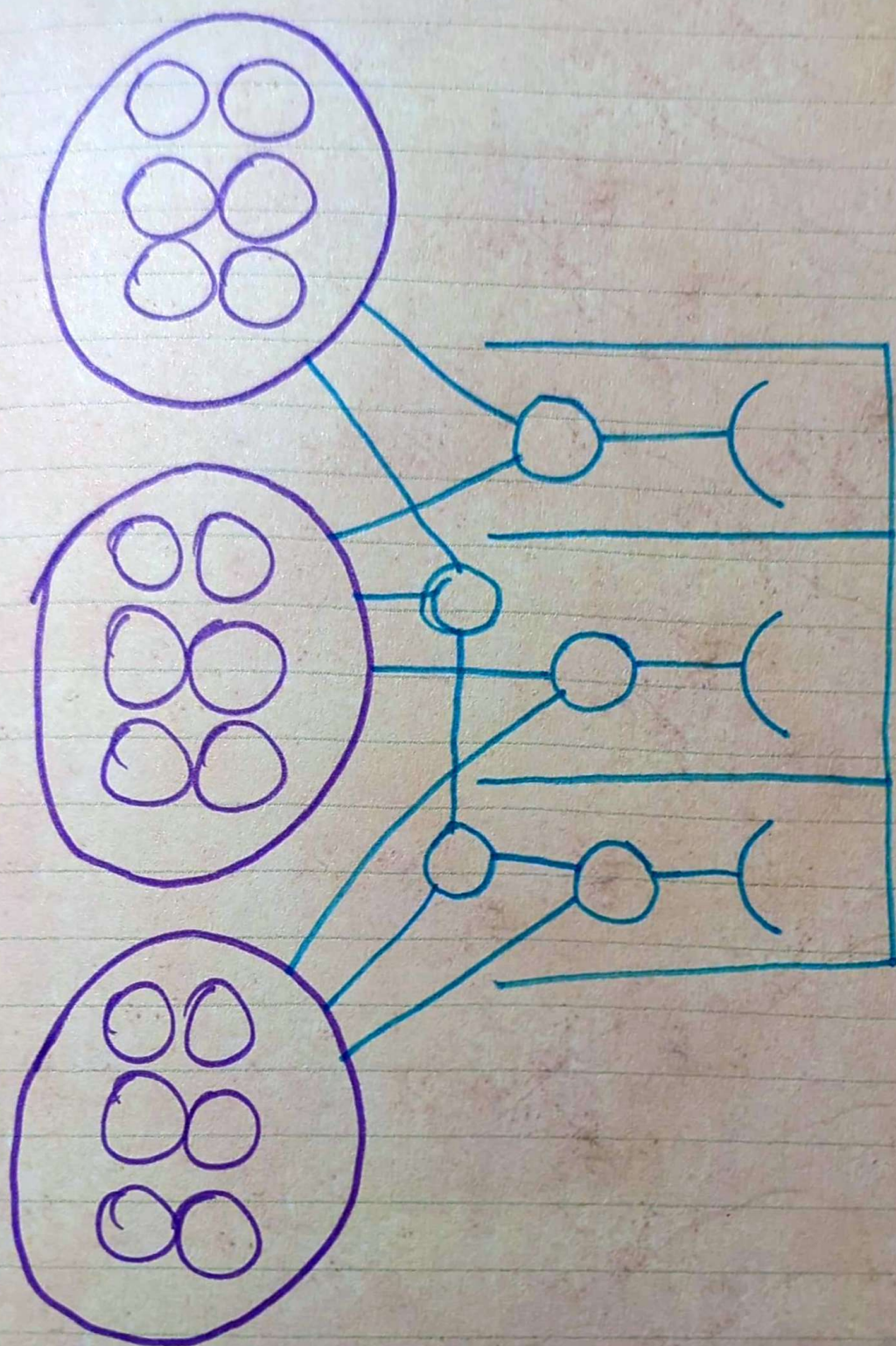



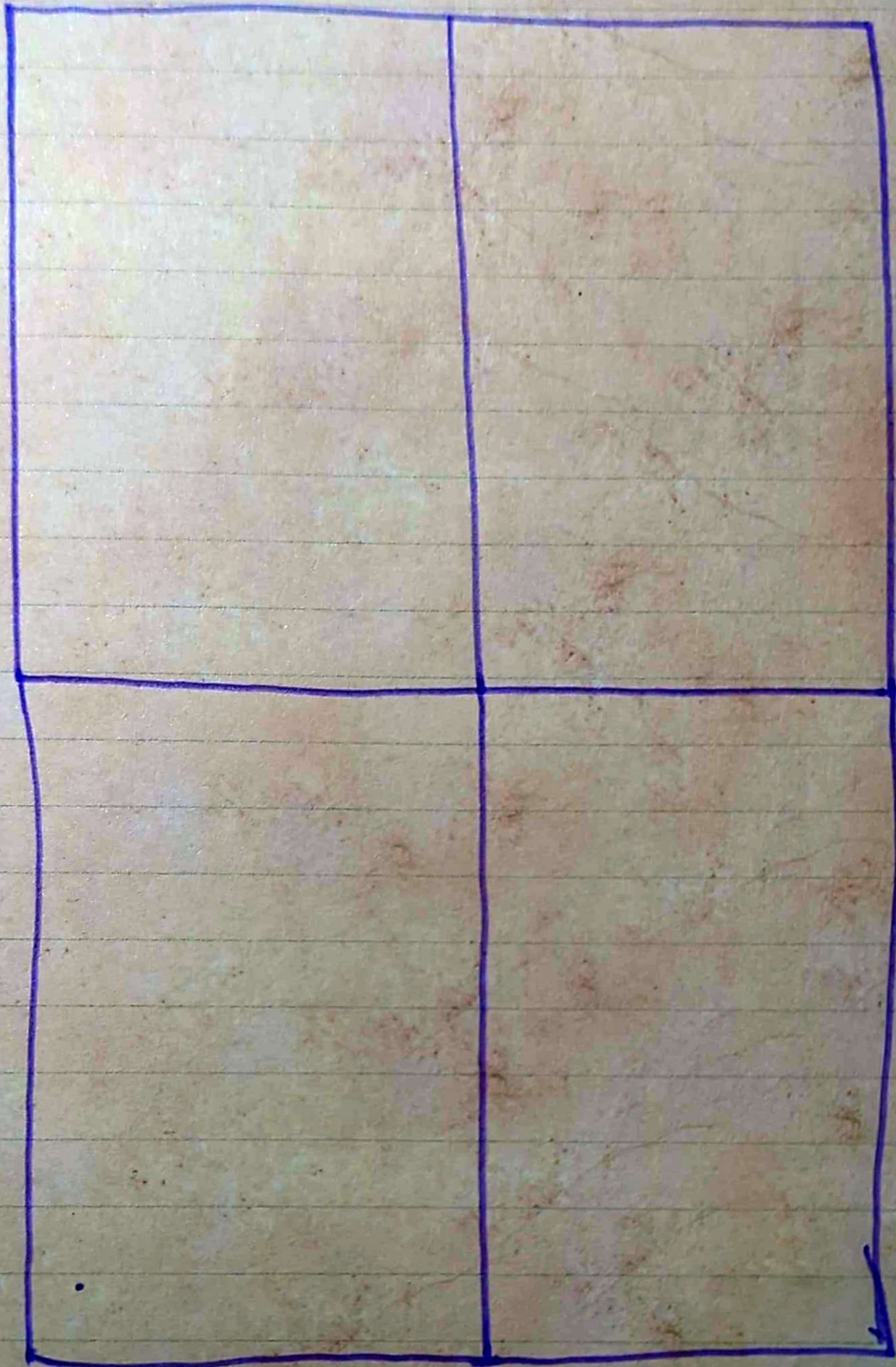





caffeine  
nicotine  
morphine

adenine  
thymine  
guanine  
cytosine

dopamine  
serotonin  
adrenaline  
endorphin

chemicals

nucleotides

neurotransmitters

si	12	sol	12	mi	12
la	24	fa	24	re	24
sol	48	mi	48	do	48
fa	96	re	96		
mi	192	do	192		
re	384				
do	768				



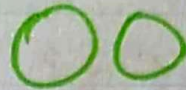
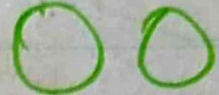
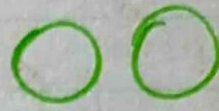
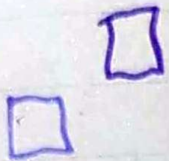
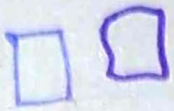





A microscope is for viewing small.  
A telescope is for viewing far.  
A kaleidoscope is for viewing colors.



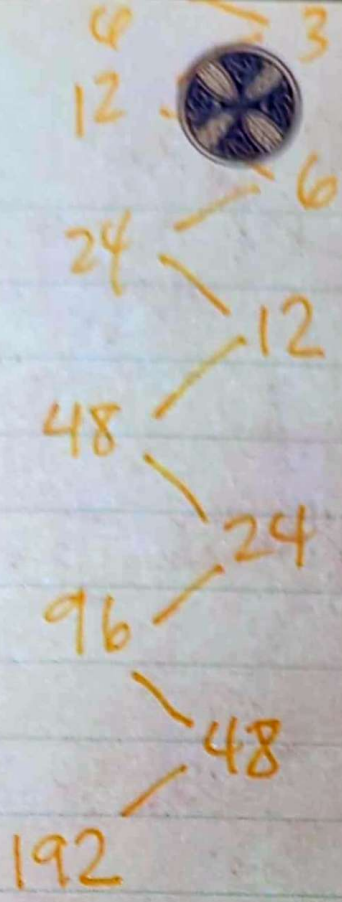
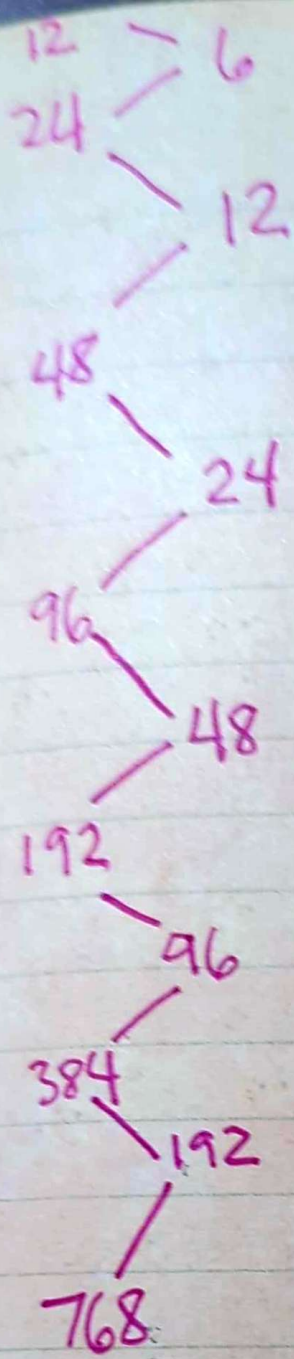





3

12 6 12

24 12 24

48 24 48

96 48 96

192 96 192

384 192

768 384



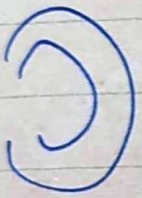
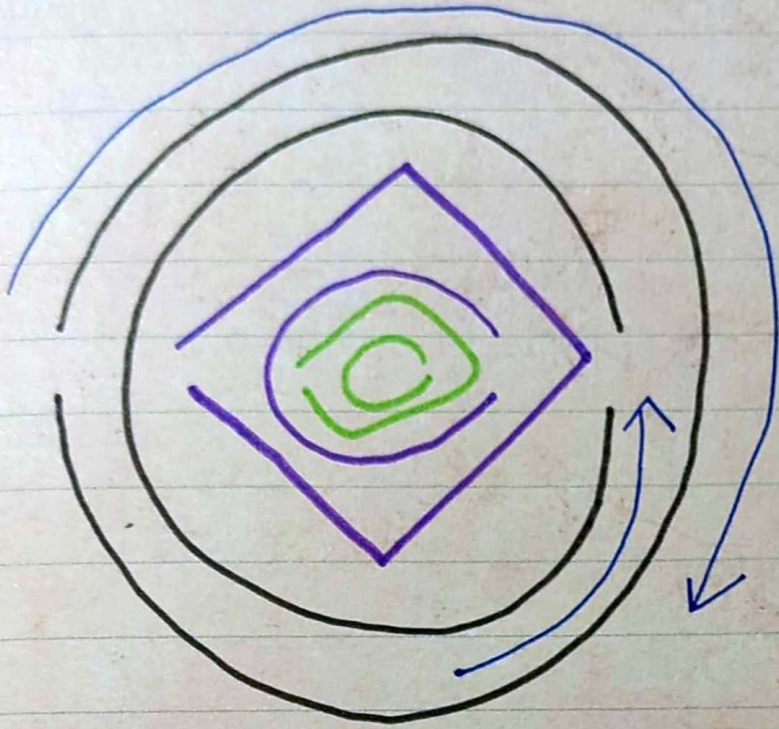

undo →

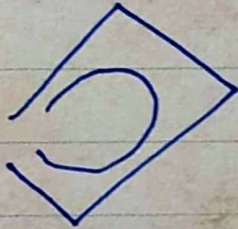

undo

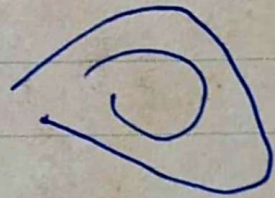

undo





Double journey moves across signals orbiting  
at right angles in a growing spiral until....

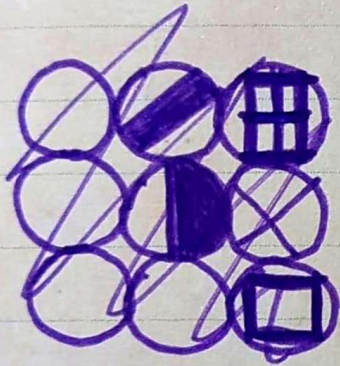





Prunam

Noun      Verb      Adverb      Adjective

Subject      Predicate

Proper      Action

Thing      Doing

Person

Place

Event

Object

Article

Preposition      Conjunction      Gerund      Infinitive

and, but, or  
+   -   +/ -

~~Noun Verb Adverb~~

winter (noun) (The birds (subject) fly (verb) south (noun) for (preposition) the (article) winter (noun) to be warmer. (infinitive))

(prepositional phrase)





The bird → talking about a specific bird  
A bird → talking about a general bird  
The birds → talking about either one  
Birds → general or specific class needs

plural = little vague

The pencil is here.  
A pencil just arrived.  
Pencils need to be sharpened.  
The pencils on the shelf are mine.

Pencils My pencils

Your pencils

His/her pencils

My bird

Your bird

My birds

You're a bird

Our bird

You're the bird

Our birds



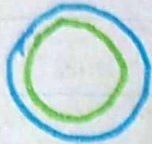
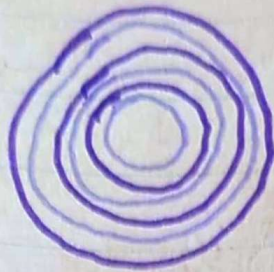





1	1	1						
2	3	2				H1		—
3	2	3	2	2	2			
			4	6	4	H3		Essence
4	4	4	6	4	6			
8	12	8				H6		Thoughts
12	8	12	8	8	8			
			16	24	16	H12		Emotions
16	16	16	24	16	24			
32	48	32				H24		Movement
48	32	48	32	32	32			
			64	96	64	H48		Impressions
64	64	64	96	64	96			
128	192	128				H96		Blood
192	128	192	128	128	128			
			256	384	256	H192		Air
256	256	256	384	256	384			
512	768	512				H384		Water
768	512	768	512	512	512			
			1024	1536	1024	H768		Food
1024	1024	1024	1536	1024	1536			
2048	3072	2048				H1536		Wood
3072	2048	3072						



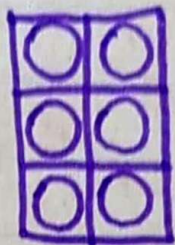
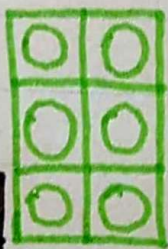
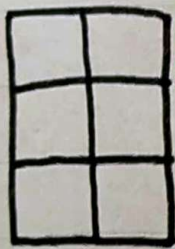





48

192

768



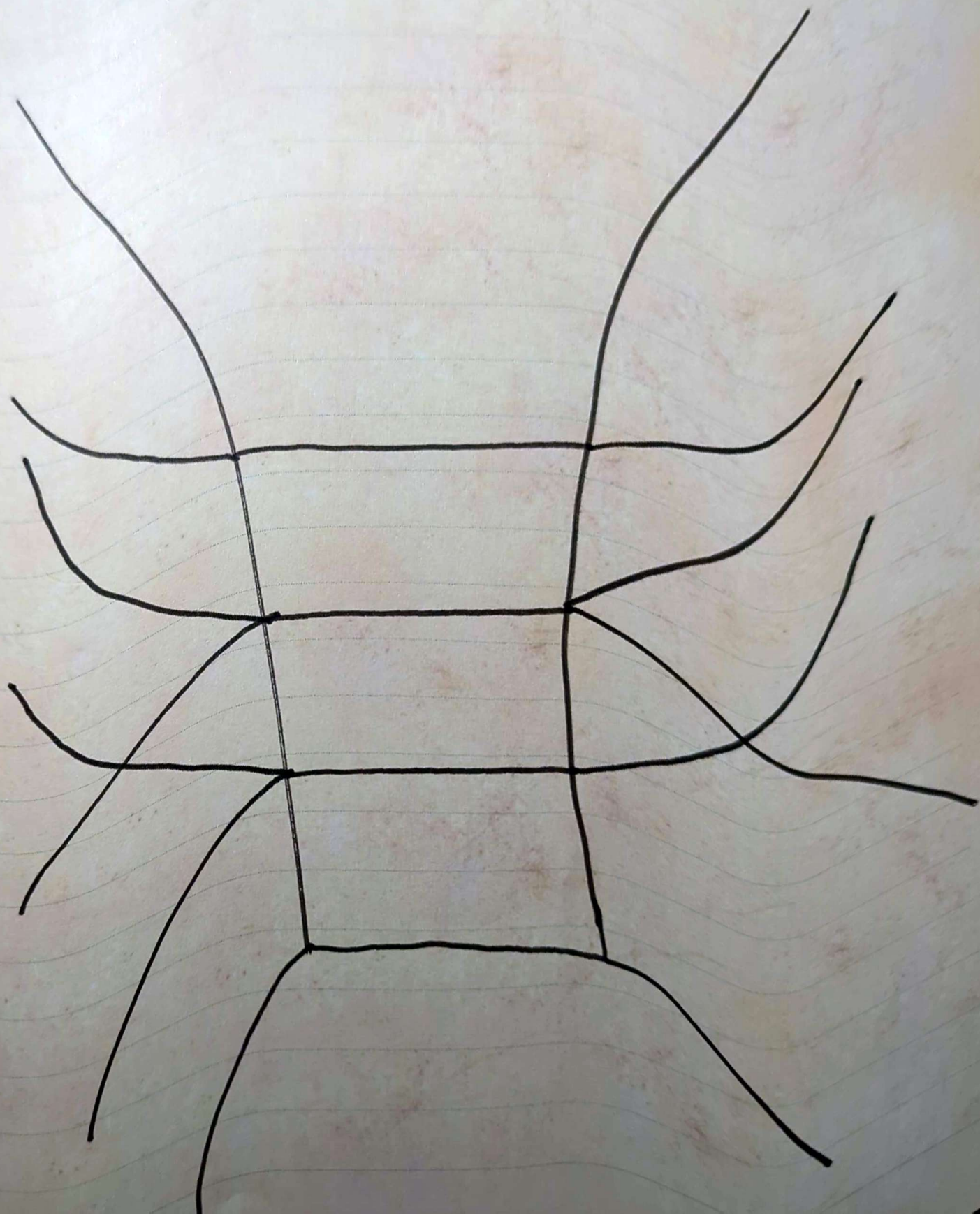



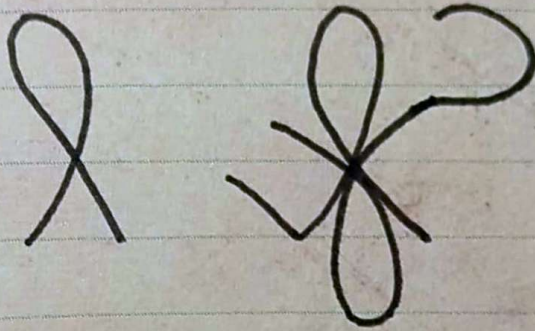
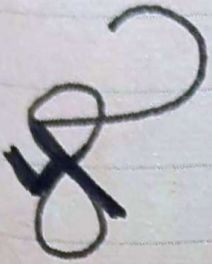
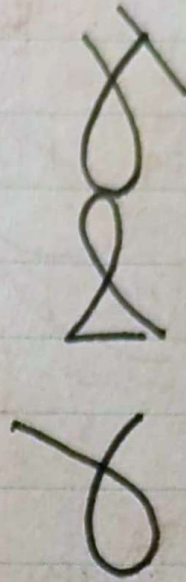
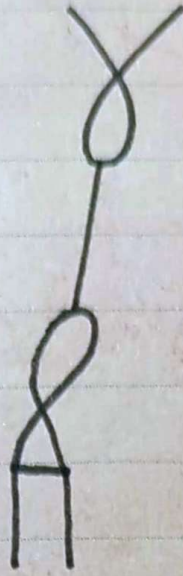
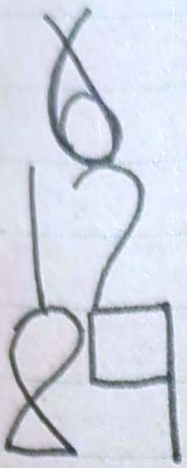

1 2 4 8

3 6 12

9 18

27

9

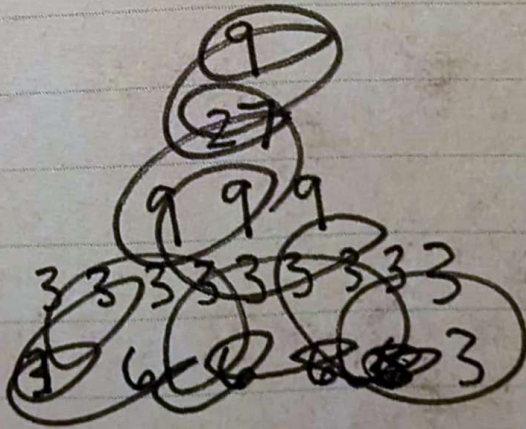

1 3 6 12

4 9 18

13 27

40

4

1 4 2 8 5 7 9

5 6 10 13 12

11 16 23 25

27 39 48

66 87





I am never sharing with Settin.  
I am never telling Settin anything.  
I am never going to tell Settin things.

I am never willing to respond to vampires.  
I am never able to give away gold.  
I am never trying to "enable" people.  
I am never selling out my life story.

I am never submitting to evil.

Settin and Satan  
will lose to Good.

ARG!

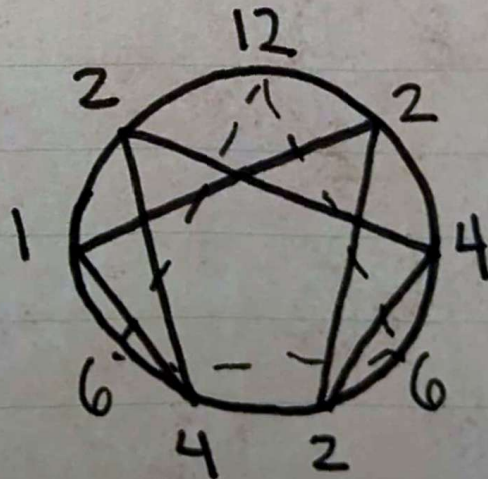





6144 [54, 14,  
 3072 [20, 42, 27,  
 1536 [50, 14, 93, 54,  
 768 [98, 104, 90] {863}

Hydrogen 384

po. neg.

hydr ↑ (lowr) ↓

384 (6)	192	<sup>27</sup> [20, 18,] {18}
3x12 [36]	96	[{54}]
3x8x4 {96}	48	[{32}]
<del>24x4</del>	24	[{8}]
11x4 [44]	12	[{2}]
7x8 [56]	6	[{6}]
	3	[{3}]
	1	[{1}]





	+	x	+x
1	1	1	1
3	3	3	3
6	6	6	6
12	3	2	3
24	6	8	6
48	12	32	12
96	15	54	15
192	12	18	27, 22, 11
384	15	96	56, 44, 36
768	21	96	98, 90, 104
1536	15	90	<del>14, 48,</del> 50, 44, 36, 54
3072	12	42	
6144	15	96	
12288	22	256	
24576	24	720	





- When you smile at a stimulus, they take this response as affirmative for their secret intention. Instead of affirmative, we believe it should be acknowledgement, not of secret intention even, but of their stimulus.



problematic:

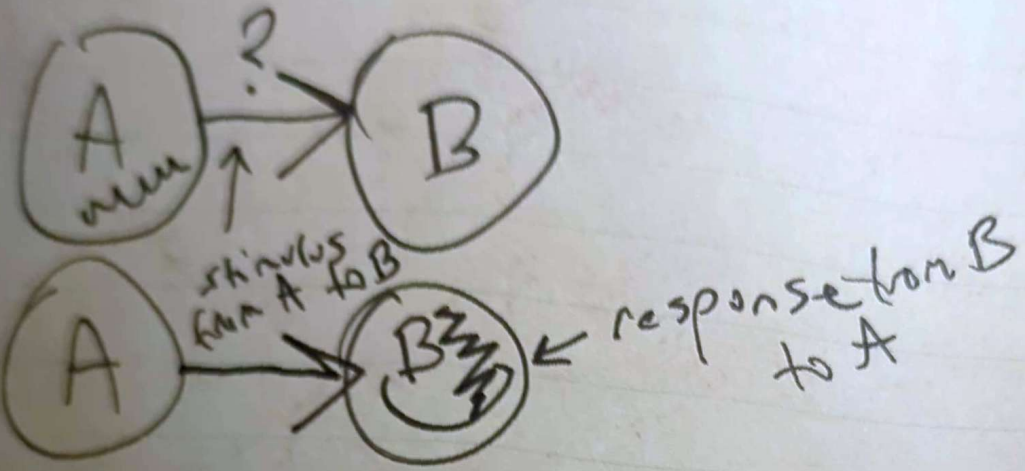
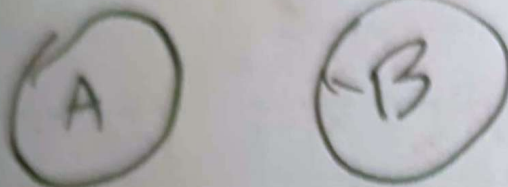

should be ~~transference~~ mm?

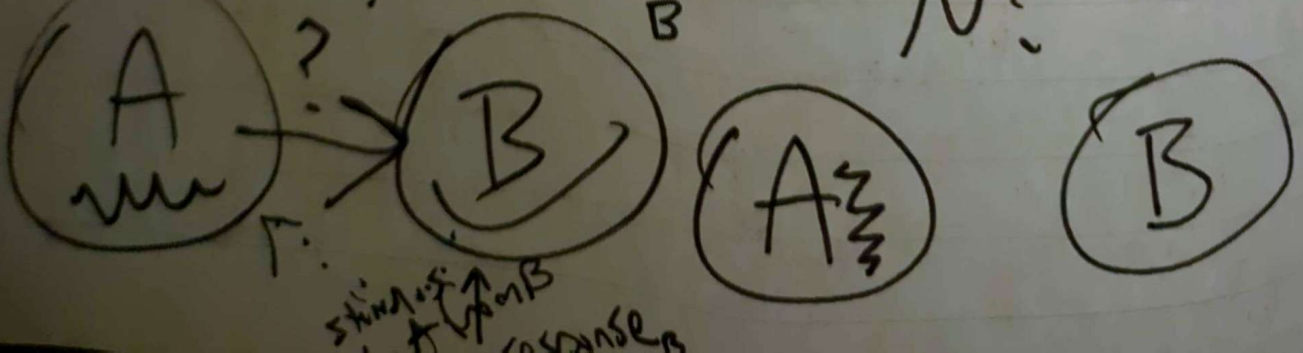
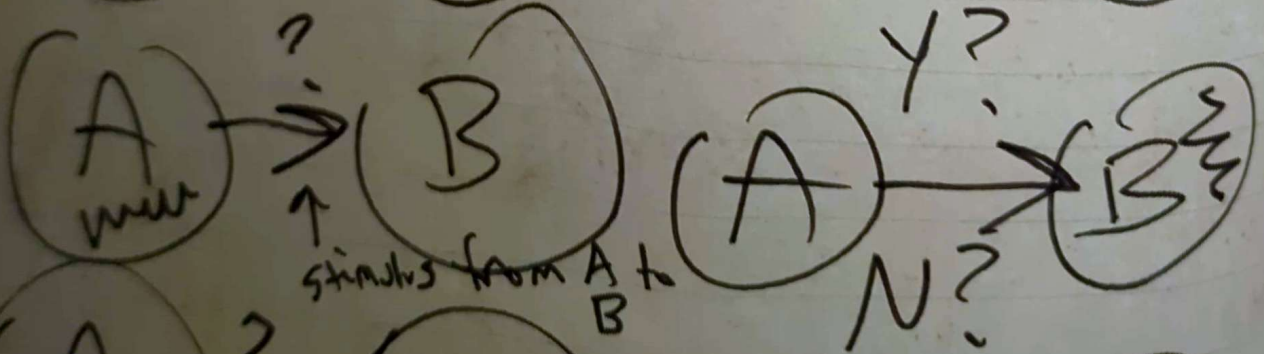
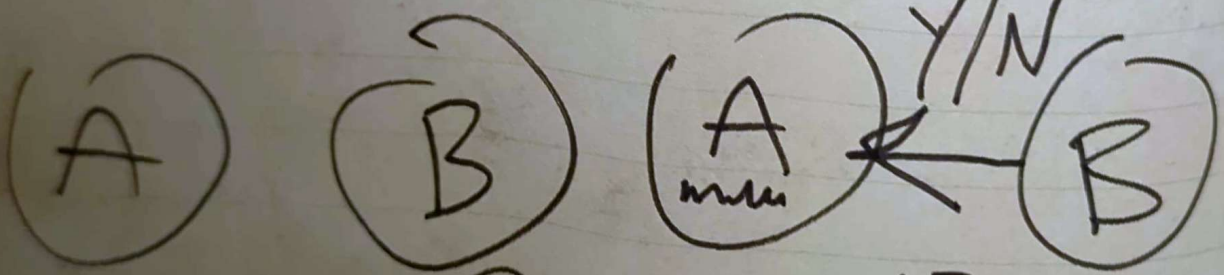



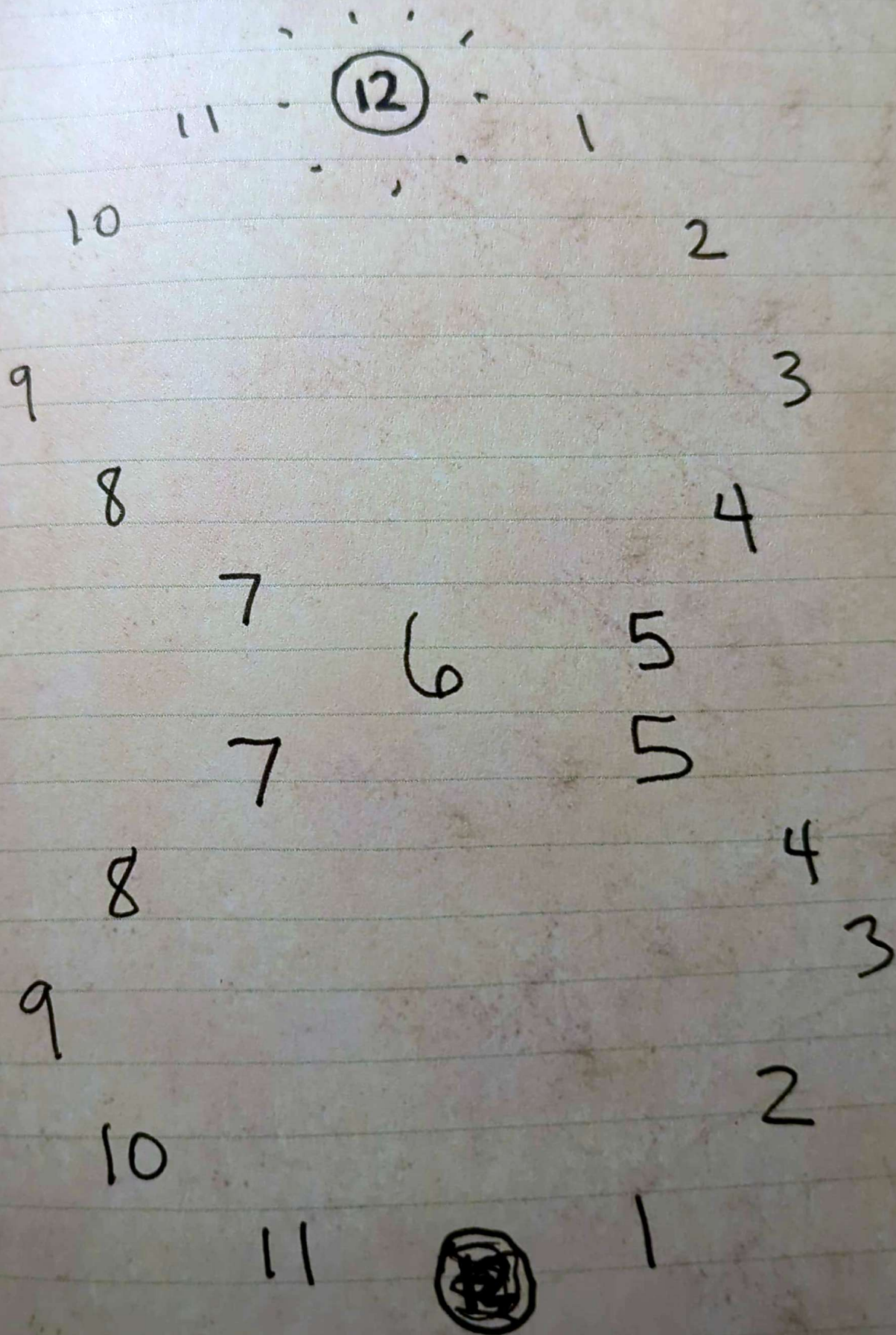



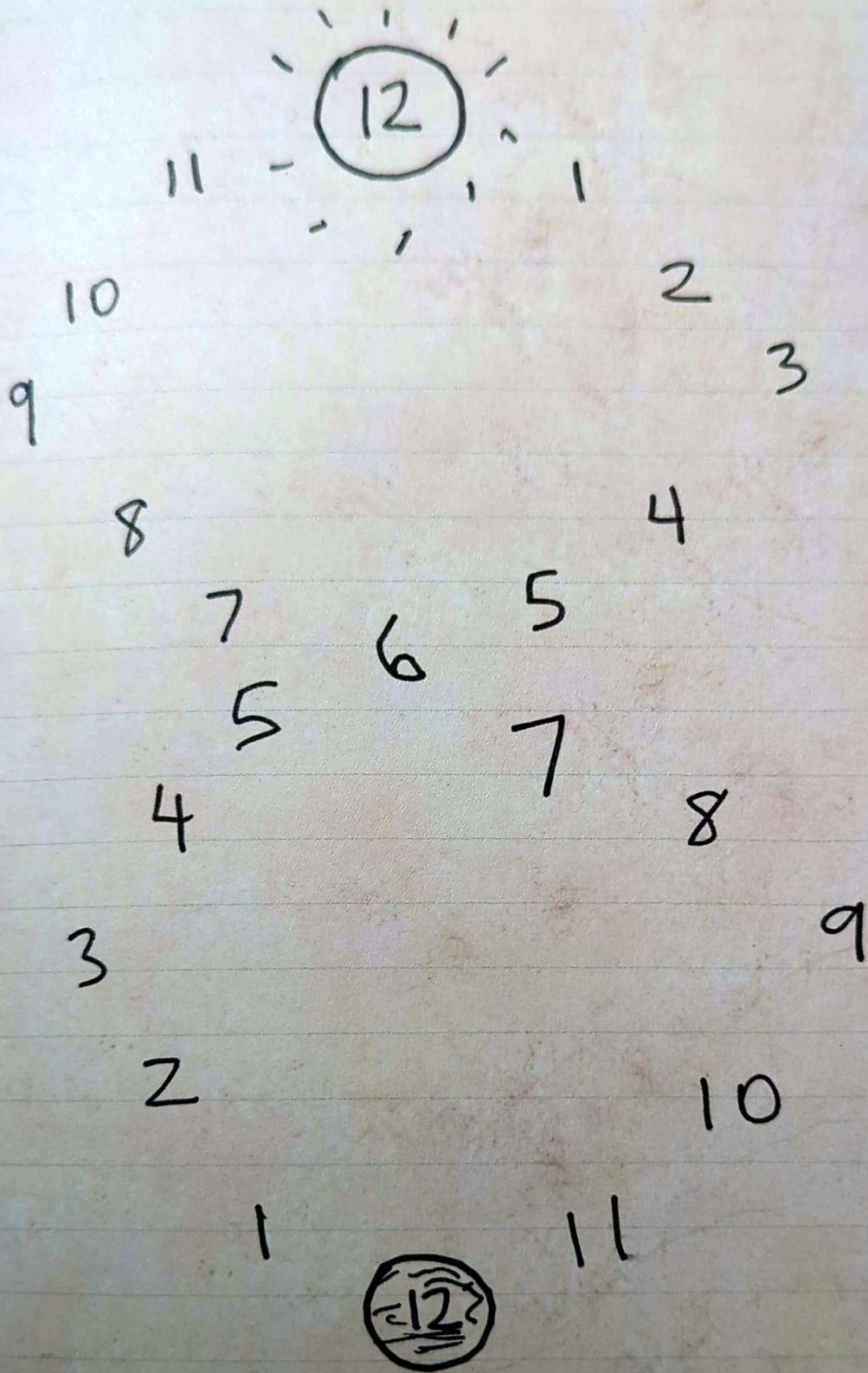



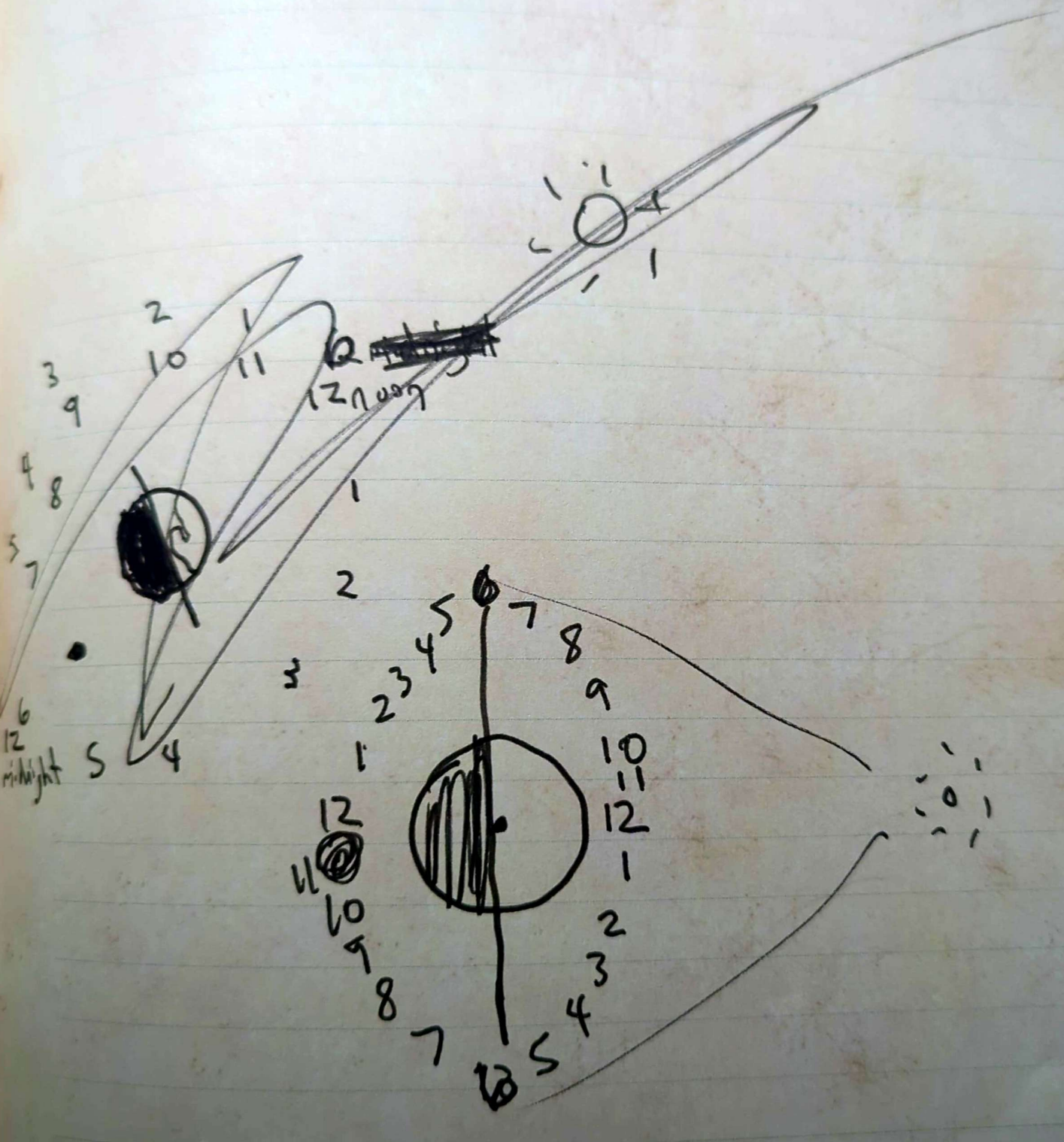



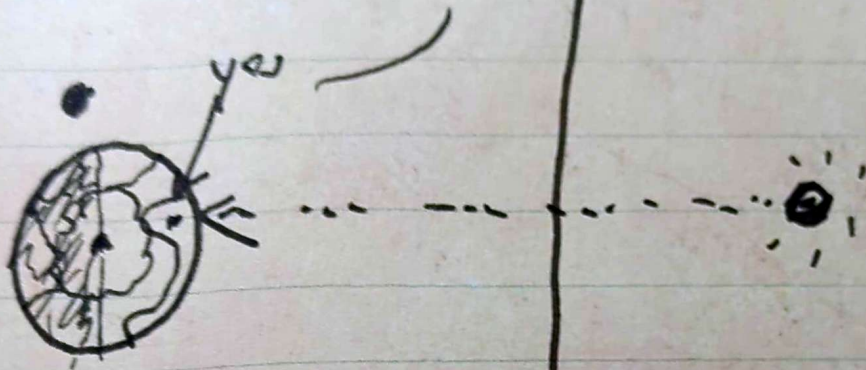

2

2





sun

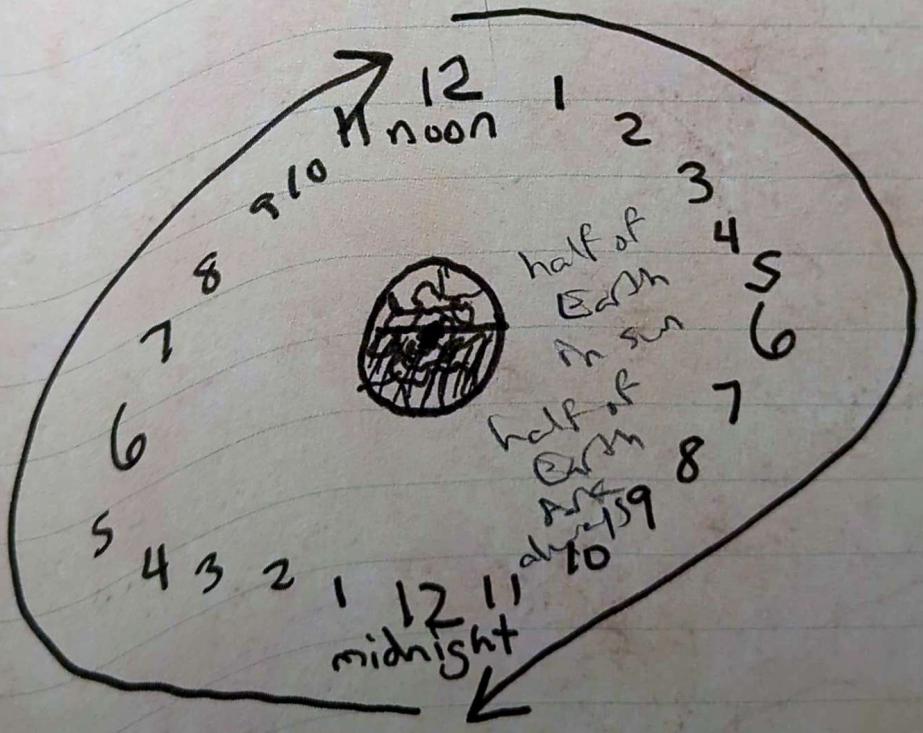

read

write

2

2





1 2 1  
9 3 6 3 9  
7 6 12 6 5  
10 20 10  
8 12 12 4  
9 24 24  
10 12 8 8 3  
11 9 6 9 4  
10 7 8 7 6 5 4

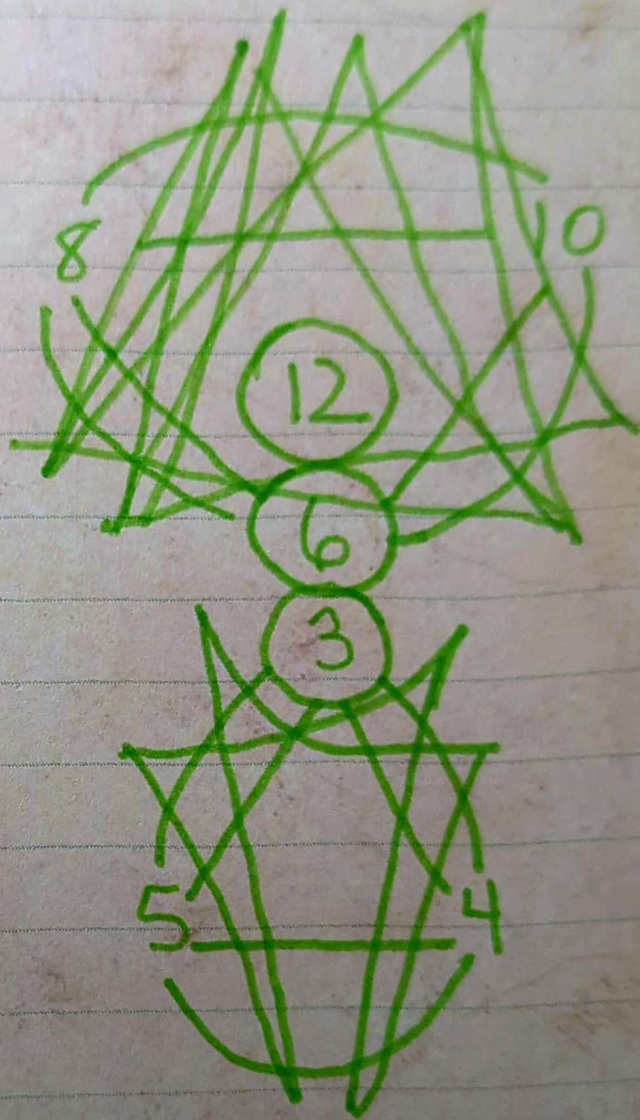



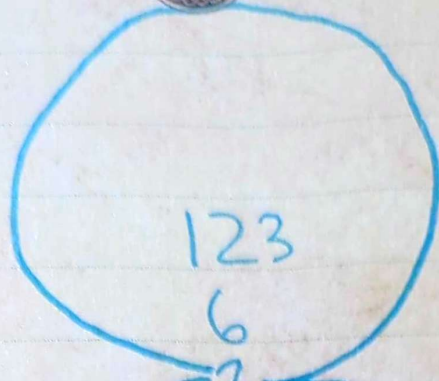

123

6

3

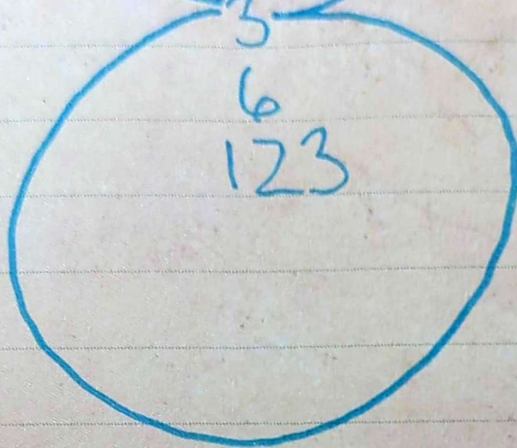

6

123

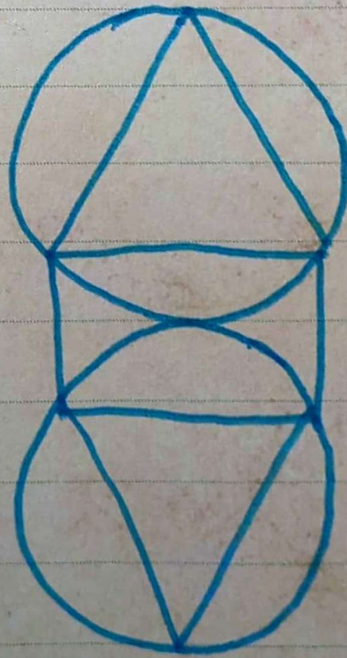

Judge not lest ye





12

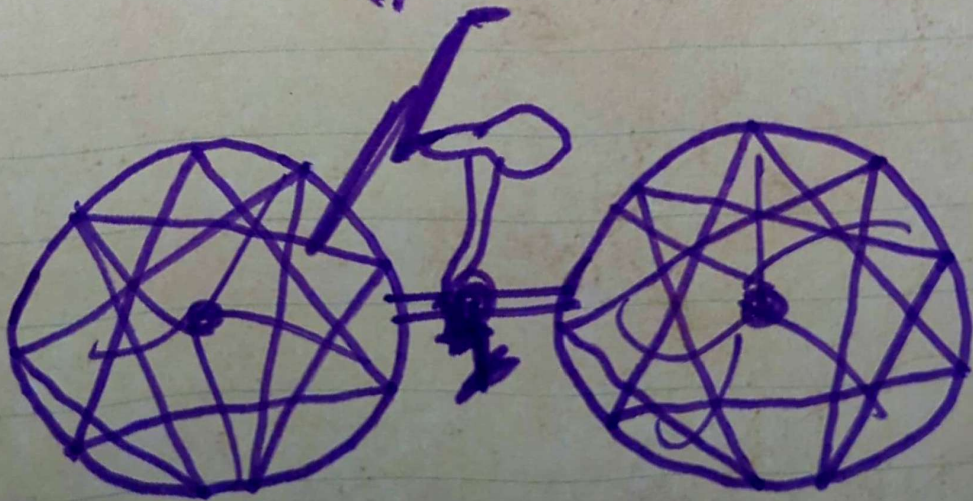
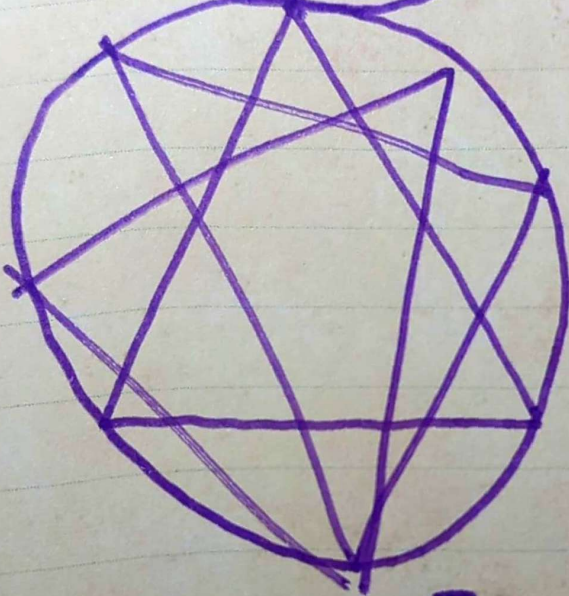
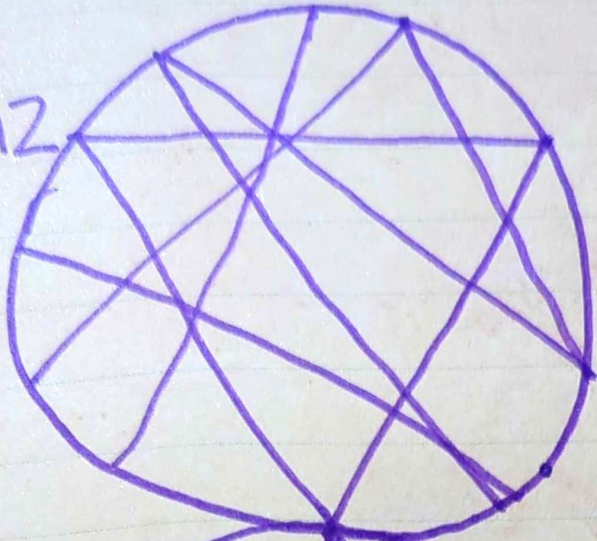





What is your secret?

My secret is my secret

Your secret is your secret

His secretions are his secretions

Hers are hers.

Mine is mine.

I have a few secrets.

Sleep  
Rest



Dreaming

Falling Remembering

Waking  
Sleep



Rising



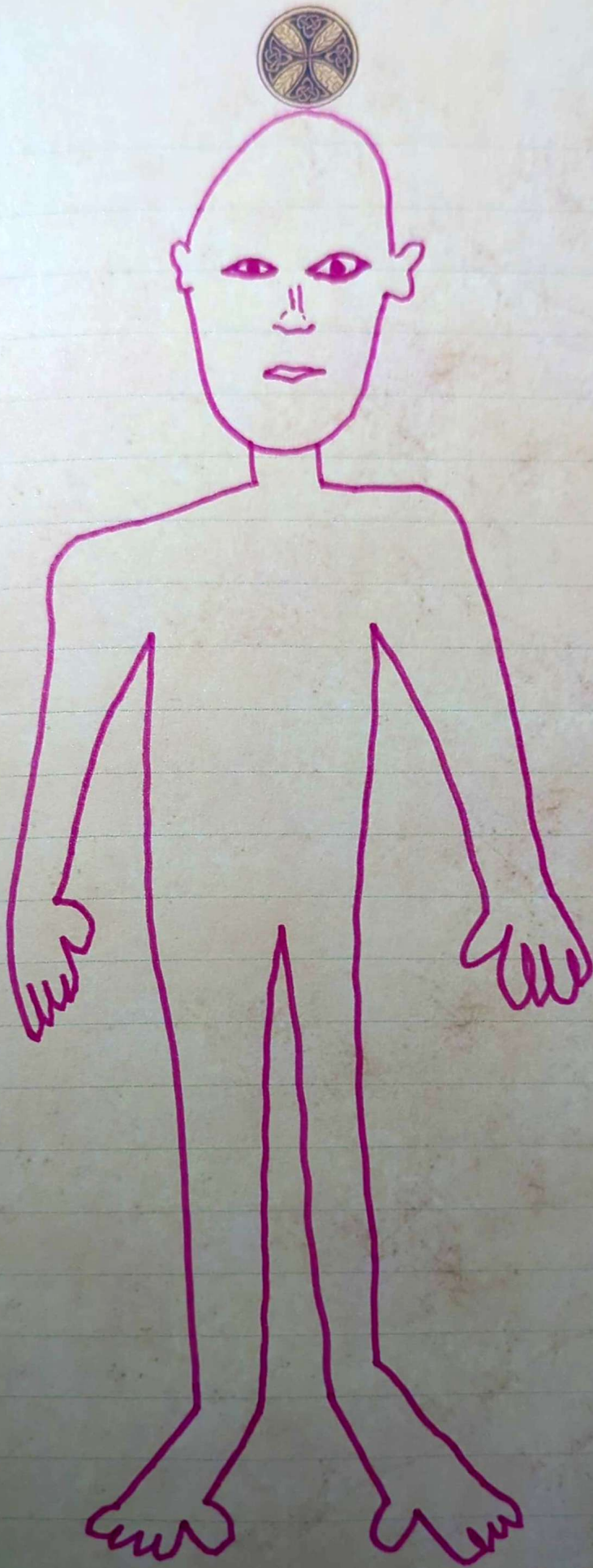



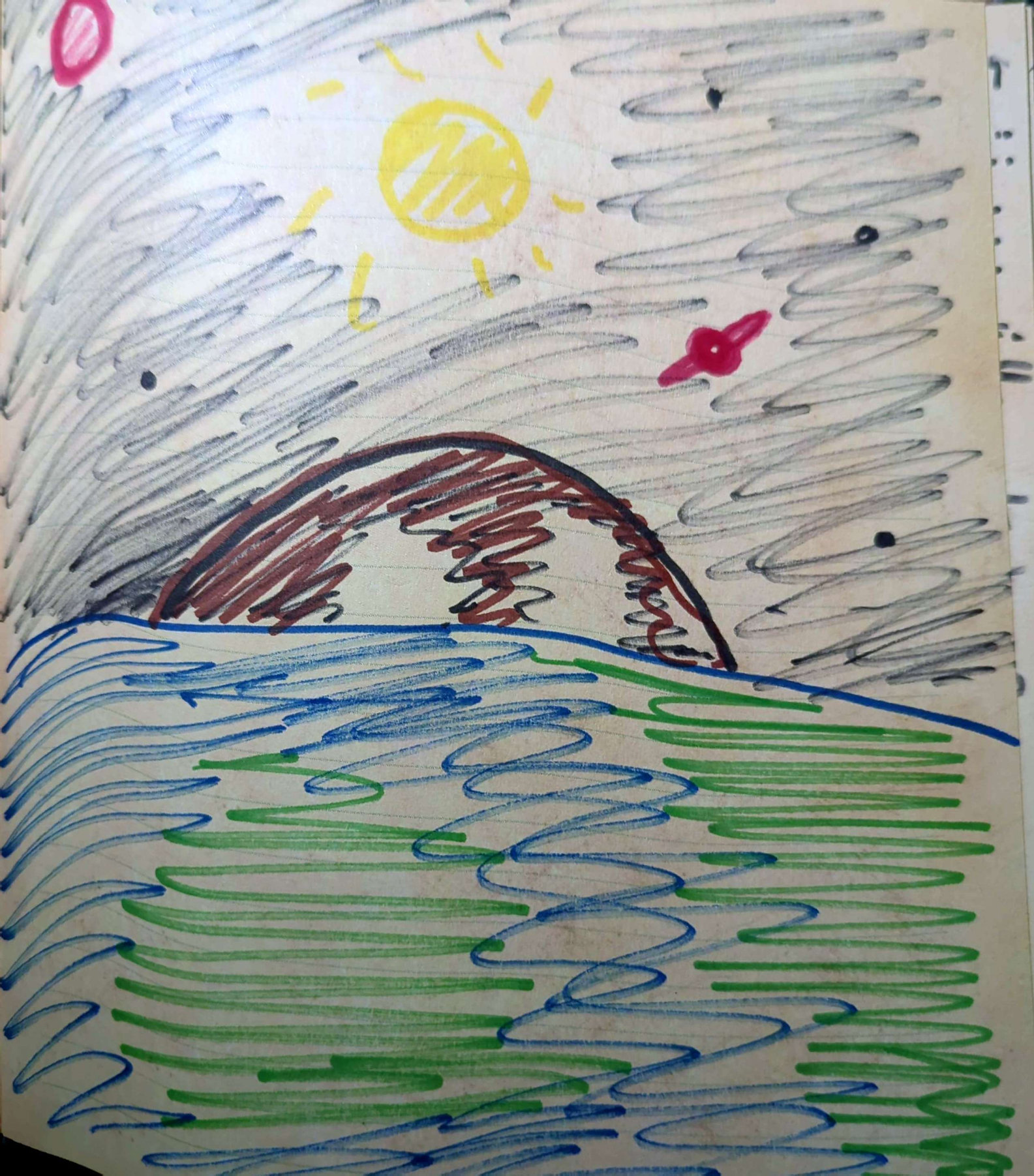



hexadecimal



HEX = 0123456789  
ABCDEF

RR GG BB

0x00 - 0xFF  
0 - 255  
1 - 256

#00 → #FF  
~~light~~  
Dark Bright  
Dark Bright

Darkest

00 10 20 30 40 50 60

70 80 90 A0 B0 C0 D0

E0 F0 FF - Brightest

#FF0000 #00FF00 #0000FF  
#900000 #009000 #000090





God

Human Race Mind

{ Collective Unconscious  
 { Living God  
 { Infinite Creator

Always Anytime Awake

Already Aware Anywhere

Permission	Allowance	Temperance
Appreciation	Possibility	Compatability
Availability	Acceptance	Secrecy
Accuracy	Precision	Manners

Dharma	Knowledge	Compassion	Virtue
(12) 3H	Awareness	Love	Self-Remember
(18) 8E	Being	Wisdom	Self-Observat
4A	Understanding	Forgiveness	Non-Identific
(24) T	Kindness	<del>Memory</del>	Non-Attachm
Pride H	Desire	Non-Expression	Righteousn
Vanity	Non-Violence of	Negative Emotions	Karma



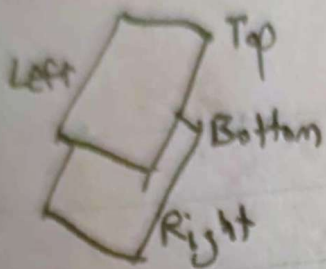

C capacitance  
 $\mu F$  (farads)

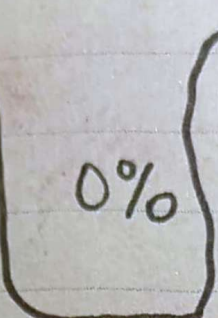
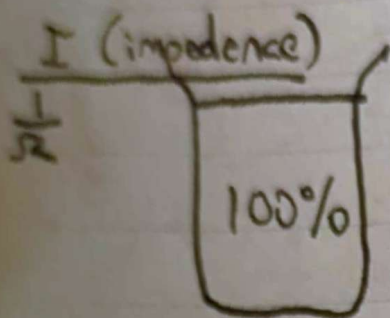

I current  
 $\mu A$  (amps)  
 V voltage  
 $\mu V$  (volts)

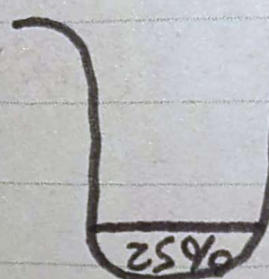
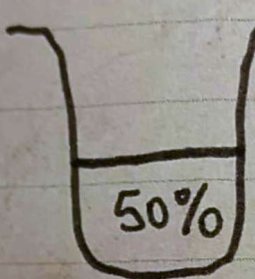
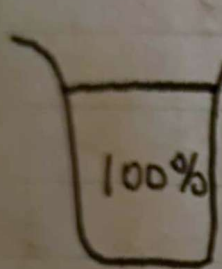

R resistance  
 $\Omega$  (ohms)  
 L inductance  
 $\mu H$

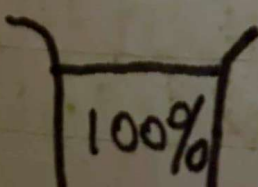
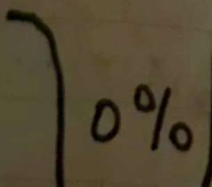
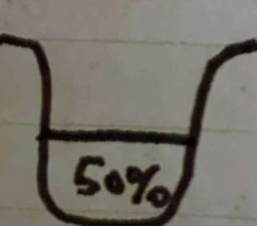
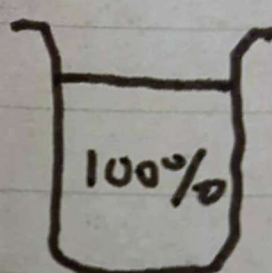
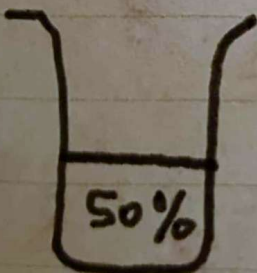
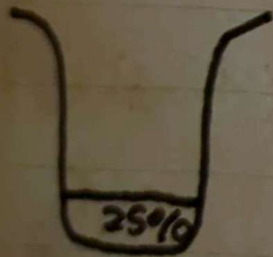
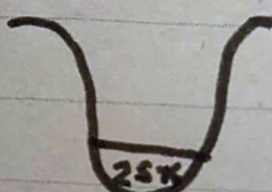
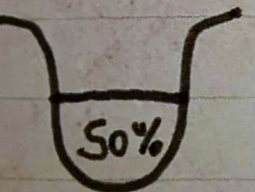
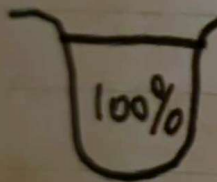



KVL

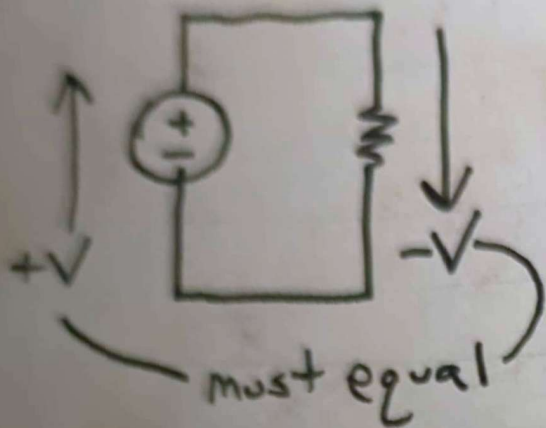

total voltage in  
cdd them

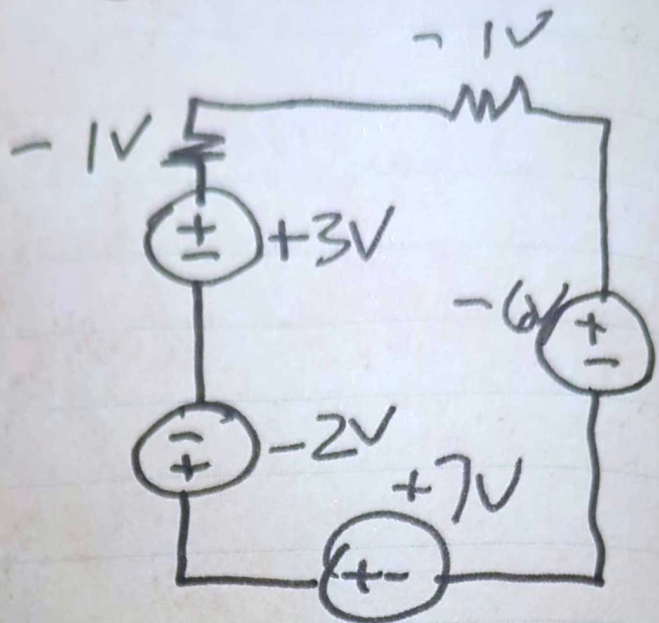

circuit equals ~~zero~~

KCL

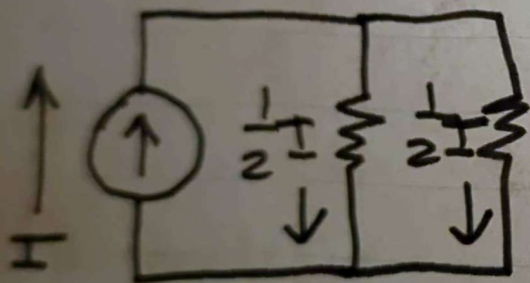

current entering into  
a loop must equal  
current leaving loop

total current around a closed loop = current sources summed

Ohm's Law  $V = IR$

Volt Amps

(x = .)

$W = Fd$

$F = ma$

F Force

m mass

$P = VI$

P Power

N (Newton)

g (gram)

W work

a acceleration

m/s<sup>2</sup> g

d distance





Living God  
Collective Unconscious  
Infinite Creator

Mouni Sadhu  
Jung  
Family of  
Light

---

Perfect

~~Wise~~

Wise



can't be solved  
of numbers

?

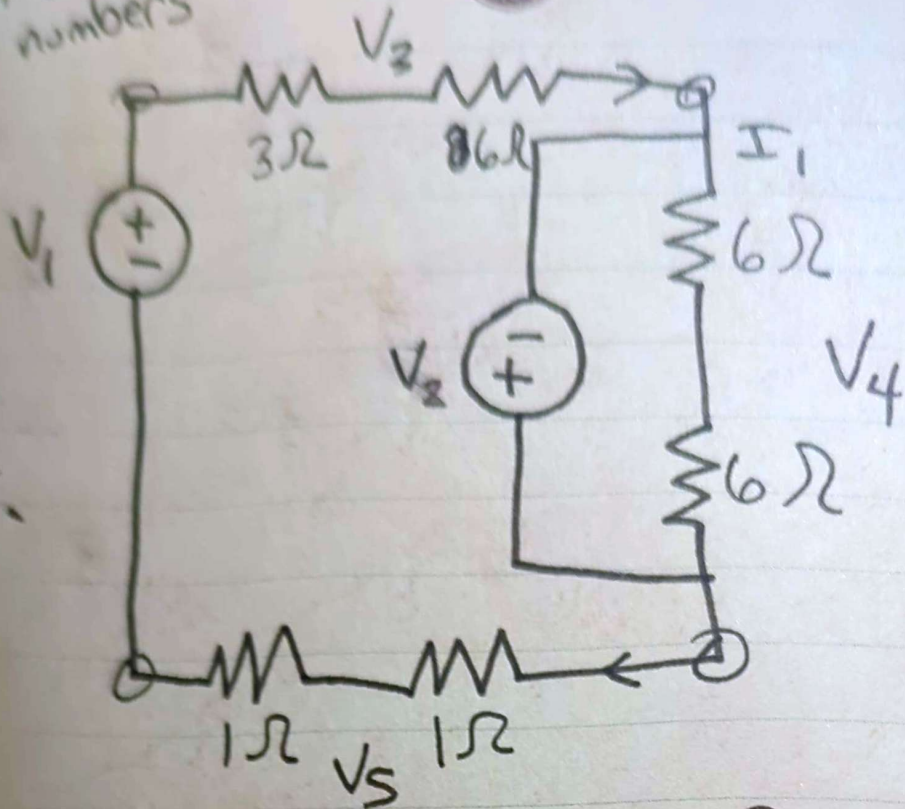

$$V = IR \quad R = 9\Omega \quad R = 12\Omega \quad R = 2\Omega \quad 9\frac{2}{3}\Omega$$

$$R = \frac{I}{V}$$

$$I = \frac{V}{R}$$

---

$$V_2$$

---

$$11I$$

$$V_1$$

$$0 = V_1 - \frac{9I_1}{V_3} \quad V_2 = I_1 \cdot 12$$

$$V_2 = 12I_1$$

$$\phi = V_1 - \frac{9I_1}{V_3}$$

$$2I_1$$

$$9I_1$$

$$V_1 = 23I_1$$

$$9\frac{2}{3}I_1 = V_x$$

$$\phi = 23I_1 - \frac{23I_1}{9} - \cancel{\frac{23I_1}{9}} - 12I_1 - \frac{2I_1}{9}$$

$$(23 - \frac{23}{9} - 12 - \frac{2}{9})I_1 = \phi = V_x$$





- Spark
- Voice
- Call Sign

} Tuning

- Ember - watch if you <sup>can</sup> see
  - Smoke - Listen if you can hear
  - Thought - Avoid bleed through
  - Communication - Luck
- on Synchronicity

$$123456789 \times 8 = 987654231$$

$$112233445566778899 \otimes x = x \otimes 10^Y$$





666

CANNIBALISM

666

777

VERSUS

VAMPIRISM

to we, or not to we  
to we we, or not to we.  
that is no question  
that is just plain silly